

## New All-Purpose Door Guard

***NUDV - 00***

***NUDV - 01***

***NUDV - 02***

***NC - mod4***

***NM - mod4***

***NKLA***



## Installation and Operating instructions

# *Welcome*

We congratulate you on purchase of “**New All-Purpose Door Guard**” (**NADG = NUDV**), which is the improved version of successful “All-Purpose Door Guard” (ADG = UDV). This all-purpose guard will widely manage to satisfy your needs of communication with persons at the building front door or your company entry, or family house doorway. The universality lies in possibility to connect this guard to an internal line of your branch exchange regardless to type and producer of this exchange (analog line). Up to two 16-digit numbers, including “ ρ ”, “ # ”, **Pause** and **Flash** in tone dialing, can be programmed to each button.

The basic guard module is supplied either without button, or with one or two buttons. Further the whole system allows to be enlarged by NC-mod4 and NM-mod4 modules up to 64 buttons using the basic mechanical MK1...MK4 units. The whole assembly can be completed with cover frame or rain-protective canopy both under plaster, and on plaster.

The guard is supplied from branch exchange line – his features remind a loud telephone. The basic features include the possibility to open up to two doors by means of connected electrical locks (the first 10 buttons can be used for door code opening) and easier programming by either through serial line (or USB) from PC, or using the telephone with tone dialing in two ways, either by communication with guard after entering 4-digit service password, or connecting the programming stretcher on guard basic board. Having been forgot the service password it is possible to use the second way.

# Table of Contents

---

<b>1</b>	<b>BASIC DESCRIPTION.....</b>	<b>5</b>
1.1	FEATURES .....	5
1.2	MODULE ASSEMBLY .....	6
1.3	MODULE FEATURES .....	7
1.3.1	<i>NUDV Basic Module.....</i>	<i>7</i>
1.3.2	<i>Extending Module with NC-mod4, NM-mod4 Buttons.....</i>	<i>10</i>
1.3.3	<i>NKLA Keyboard Module.....</i>	<i>11</i>
1.3.4	<i>Other modules.....</i>	<i>11</i>
1.4	INSTALLATION OF GUARD ASSEMBLY .....	11
1.4.1	<i>Installation on Plaster.....</i>	<i>11</i>
1.4.2	<i>Flush-Mounted Installation .....</i>	<i>11</i>
1.5	CHANGE OF NAMEPLATES .....	12
<b>2</b>	<b>ALL-PURPOSE GUARD OPERATION.....</b>	<b>13</b>
2.1	SIGNALING OVERVIEW.....	13
2.2	VISITOR AT DOOR .....	13
2.2.1	<i>Guard without Keyboard .....</i>	<i>13</i>
2.2.2	<i>Guard with Keyboard .....</i>	<i>14</i>
2.3	PERSON INSIDE OBJECT .....	15
2.3.1	<i>Outgoing Call .....</i>	<i>15</i>
2.3.2	<i>Incoming Call .....</i>	<i>15</i>
<b>3</b>	<b>PROGRAMMING OF PARAMETERS.....</b>	<b>16</b>
3.1	PROGRAMMING THROUGH PHONE.....	16
3.1.1	<i>Entry to Programming .....</i>	<i>16</i>
3.1.2	<i>Programming of parameters.....</i>	<i>16</i>
3.2	PROGRAMMING FROM PC – PROGRAM NSET .....	17
<b>4</b>	<b>DESCRIPTION OF PARAMETERS .....</b>	<b>18</b>
4.1	DIRECT DIALING – MEMORIES .....	18
4.2	SWITCHES .....	18
4.3	BASIC PARAMETERS .....	20
4.4	TIME PARAMETERS .....	22
4.5	PRESETTING AND DELETING .....	25
4.6	PROGRAMMING TERMINATION.....	25
4.7	SYSTEM SETTING .....	26
4.8	OVERVIEW OF PARAMETERS .....	26
4.9	LIST OF PRESETTING PARAMETERS .....	29

**5 TECHNICAL PARAMETERS..... 30**

5.1 ELECTRICAL PARAMETERS ..... 30

5.2 MECHANICAL DIMENSIONS ..... 30

**6 TABLE FOR EASY PROGRAMMING..... 31**

**7 DECT – DISTYBOX..... 33**

7.1 DISTYBOX DESCRIPTION ..... 33

7.2 DISTYBOX SIGNALING..... 33

7.3 DISTYBOX PROGRAMMING..... 34

7.4 LOG ON TO BASE STATION..... 34



# 1 Basic Description

---

## 1.1 Features

- Modular system allows to connect 1 to 64 buttons
- Voice communication is supplied only from telephone line
- Impulse and tone dialing (DTMF)
- Two 16digit numbers with each button (including ρ, #, Flash and Pause)
- Day/night switching
- Possibility of the call extension by ρ or # choice
- Possible to connect two independent locks for door opening
- Possible use of 5 switch modes (e.g. camera, lighting, gradual opening)
- Two codes for hanging up the guard from telephone
- Two codes for door opening from telephone
- Six code locks (password from buttons at the door)
- Possibility to connect a numerical keyboard this way that the guard can include 0 – 18 standard buttons
- Keyboard mode could be either direct dialing or dialing from memory
- Optional number of rings before taking an incoming call
- Optional time among button pressing by code entry
- Optional time of hanging up when the choice is repeated
- Optional time before choice start
- Optional parameters of tone choice, length of Flash and Pause
- Company setting in some levels
- Besides the company setting it is possible to preset according to two examples
- Possible programming not only by remote control, but also by direct route to PC
- Integrated heating of printed circuit
- Permanent lighting through visiting cards
- Earthing outlet pro better protection against static electricity

## 1.2 Module Assembly

The NUDV structural elements are the basic modules with two, one or no buttons and extending button modules NC-mod4 and NM-mod4 with four buttons. Further it is possible to provide the assembly with numerical keyboard and camera module. The complete assembly consists similarly to UDV system of max. 4 modules in column and max. 3 columns side by side.



Fixing frame 2      KPD2 – rain - protective cover (on plaster)      Canopy2 (flush -mounted)      Flanging frame2 (flush -mounted)

By flush-mounted assembly the MK-1 to MK-4 boxes are used as well as with UDV system.

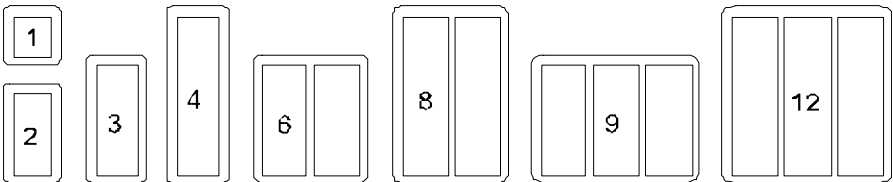

Examples of frame configuration

# 1.3 Module Features

## 1.3.1 NUDV Basic Module

The NUDV basic module is supplied in three variants – with two NUDV2 buttons, one NUDV1 button and without buttons, type NUDV0.

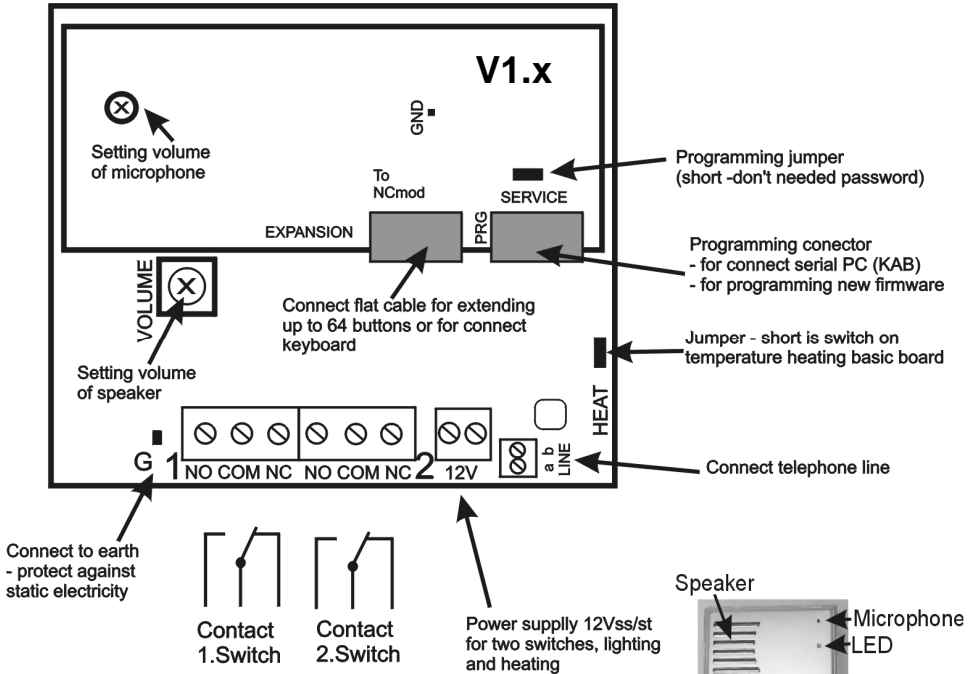

Fig. 1 Rear view of basic module

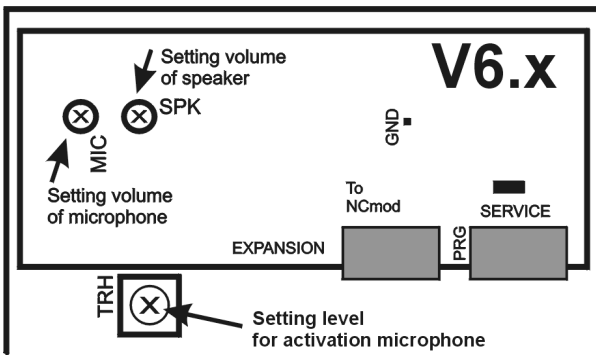
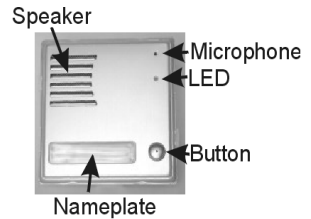

Fig. 2 Rear view of setting parts in version V6.x



To ensure the basic function the telephone line can be connected – the terminal marked as "a b LINE". It is connected in the same way as any telephone to any branch exchange. The guard's circuits are supplied from telephone line, so that nothing should be connected for voice communication.

If one or two switches are necessary to be used, the A.C. voltage of min. 10Vst - max. 15Vst or D.C. voltage of min. 12Vss to max. 18Vss must be energized to "12V" terminal. This source loading depends on number of modules, since it simultaneously serves feeding of lighting through visiting cards – at max. number of connected modules the demand will not exceed 300mA. This source can be also used for feeding of lock(s), and then it is necessary to consider the electrical lock demand. In practice the alternating feeder 12V/1A mostly meets these demands.

The connection of switch contact terminals is shown on fig. 1. The "NO" designation means an idle-disconnected contact, "COM" means a pin contact (middle) and "NC" means an idle-connected contact. The contacts of both switches are galvanically isolated each other and from other guard circuits. The variants of connection are shown on fig. 3.

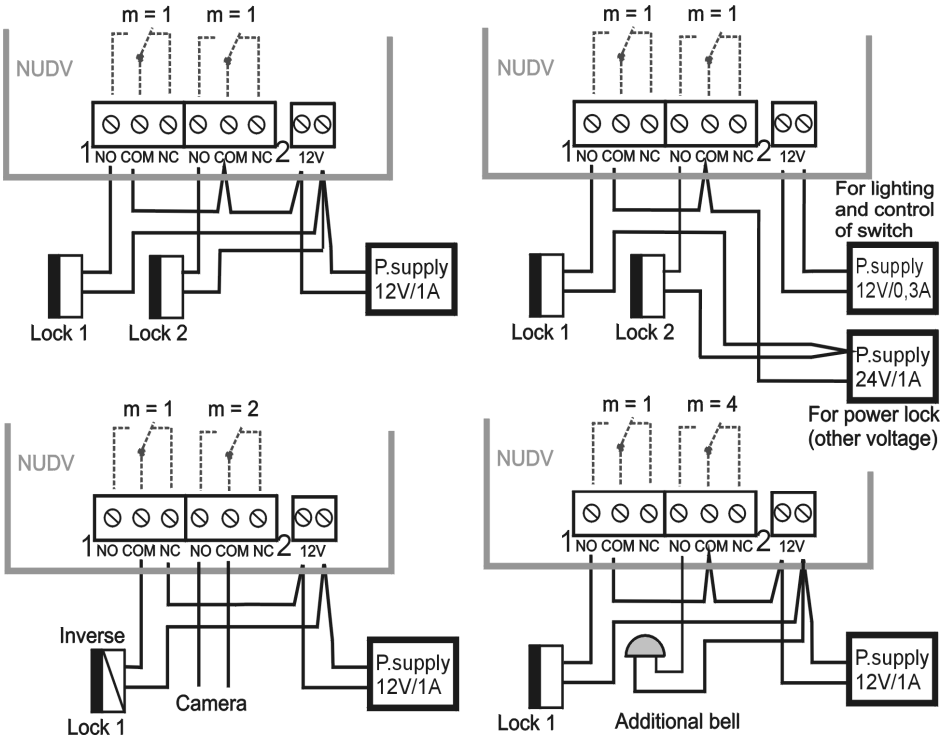

Fig. 3 Examples of switch connections

The "G" Faston 2.8mm terminal protects against static electricity – to be connected to earthing.

The "HEAT" jumper serves the switching of board heating. This function requires the connection of 12V supply on "12V" marked terminal.

The "EXPANSION" marked connector serves the connection of extending modules by means of flat cable.

The "PRG" marked connector provides the guard adjustment from PC by means of serial cable (KAB) and serves to the service for diagnostics and new software load.

The "SERVICE" jumper serves to direct access to programming. It can be used, for example by absence of password for programming.

**Setting voice communication** – position trimmers are presetting from manufacture and in majority case agree with, therefore changes setting altering only in necessary case.

**For older version of board V1.x (fig.1) :**

The "VOLUME" trimmer serves to the adjustment of loudspeaker volume, it has no effect to other guard features. The "MIC" trimmer (placed under PDV board) provides the adjustment of microphone volume. Such adjustment can improve the feature of speech way, e.g. by ambient noise in the street. At setting of a great gain of trimmer „MIC" is able to happen, that sound from speaker doorphone is interrupting, next is necessity gain of trimmer „MIC" make smaller.

**Procedure of setting:** trimmer SPK setting to maximum (turn to the right), trimmer MIC on minimum and at conversation connection subscriber speaking (in building) permanent talk, trimmer MIC turning (to the right), until sound from speaker begins interrupt, next gain teeny reducing (moving round a slight amount left). It shall everything be all right.

**For newer version board V6.x (fig.2) :**

Trimmer "MIC" be instrumental to setting loudness of microphone, trimmer "SPK" be instrumental to setting loudness loudspeaker. In this version is big reserve in gain, therefore isn't recommended adjust more than on half, typical is in 1/3 from minimum gain. Trimmer "TRH" be instrumental to setting levels activation of microphone, it means, so as doorphone "non whoop" owing to acoustic loop so selection, which direction has priority, whether from microphone, or into loudspeaker. Level from which volume with "switch on" direction from microphone doorphone setting trimmer „TRH". This setting interact level surrounding noise and setting gain of microphone „MIC".

**Progress of setting:** trimmer MIC and SPK setting in 1/4 from minimum loudness (minimum is sense turning left), trimmer TRH setting in central position. At conversation connection stilly talk and trimmer TRH turning from central value direction to the left so, till you will on the side phone (in building) hear. Gain of loudspeaker, in some case of microphone set-up according to needs.

### 1.3.2 Extending Module with NC-mod4, NM-mod4 Buttons

This module is supplied in two designs. The **NC-mod4** module has four buttons and includes the electronics to be connected to the basic module or to previous NC-mod4 module. This module is only connected by flat cable – buttons and lighting through is already interconnected. The terminals for connection of other four buttons and current supply of lighting are further placed on module (on following NM-mod4). The **NM-mod4** module is always connected to previous (in row starting with basic module) NC-mod4. The connection is not prepared and should be done by conductors – see on figure 4. The flat cable connection is facilitated by connector locks, preventing from rotation, but to keep the connection routing is imperative.

“To NUDV” is always the routing to the basic module. “To Cmod” is routing to the row end (on last NC-mod.).

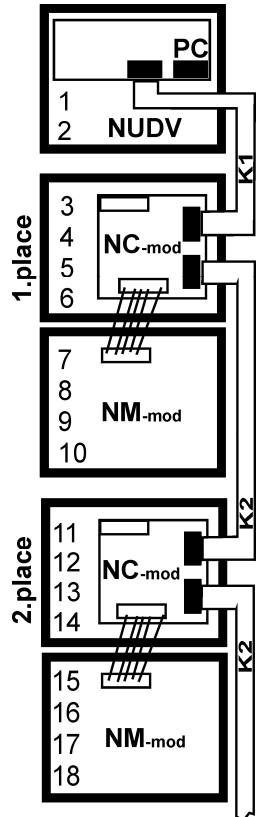
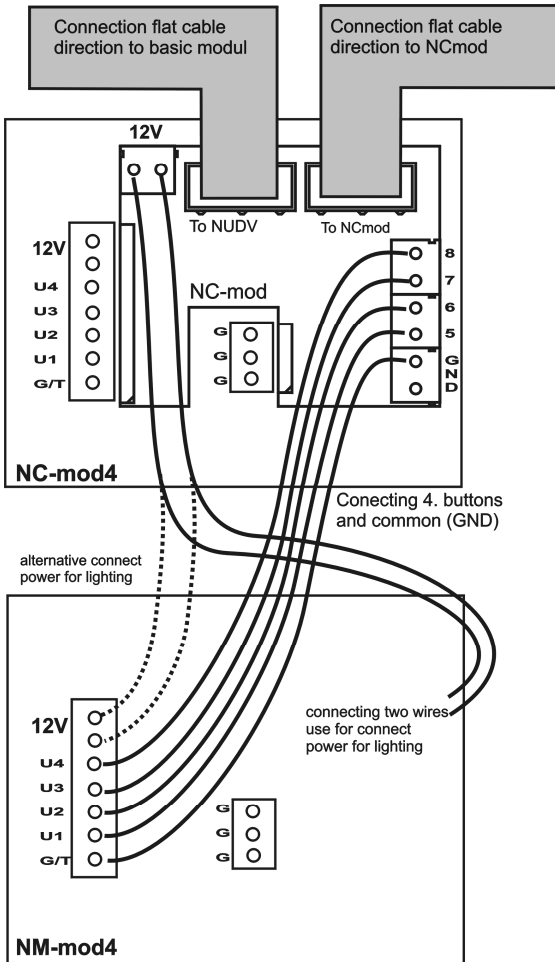

**Fig. 4 Connection of NC-mod and NM-mod and connection of modules**

### 1.3.3 NKLA Keyboard Module

The keyboard module is only connected by flat cable as well as NC-mod4 module. The only difference is that keyboard module is always the last in row (no other module can be connected behind it) and it can be only linked to the first (directly to the basic module), the second (to output of the first NC-mod4) or the third (to output of the second NC-mod4) positions. It means that 0 to 18 buttons with direct dialing can be used instead of keyboard (per assembly). The most frequent used assemblies are:

- NUDV2 + NKLA
- NUDV2 + NC-mod4 + NKLA
- NUDV2 + NC-mod4 + NM-mod4 + NKLA
- NUDV2 + NC-mod4 + NM-mod4 + NC-mod4 + NKLA
- NUDV2 + NC-mod4 + NM-mod4 + NC-mod4 + NM-mod4 + NKLA

Pay attention when programming – the position of keyboard connected must be correctly specified (parameter **48**).

The choice is entered by gradual pressing of buttons with digits. Firstly the key symbol must be pressed to enter a password. When pressing **X**, the guard will hang up.

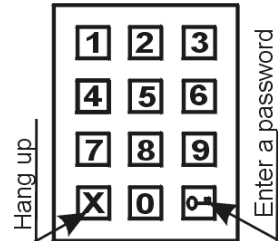

### 1.3.4 Other modules

Other modules extending the guard assembly are actually offered on [www.alphatech.cz](http://www.alphatech.cz) and can be ordered by phone or fax on number: +420272103334.

## 1.4 Installation of Guard Assembly

### 1.4.1 Installation on Plaster

By installation on plaster the only compact box - Rain-Protective Cover KPDxx is used, which will supersede all mechanical parts (MKxx, Canopy xx and Fixing Frame xx). The installation is made by screwing to the wall by means of dowels. See KPD1 on figure.



### 1.4.2 Flush-Mounted Installation

The MKxx mounting box is built-in wall. Be careful in orientation of assembling holes when nearly MK1 square box is used – it must be in vertical axis. The well-embedded box is shown on figure.

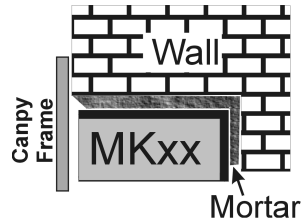

The Protecting Frame (provides overlapping of unevenness after mounting box walling-in) and Canopy (necessary for installation in external

areas) form other accessories for flush-mounted installation. When installed in surroundings with possible water condensation (temperature changes) or water spraying (rain) it is recommended to connect the jumper on basic module – heating ON.

The **board heating** has two positive functions partly it heats up the electronics in winter at temperatures below  $-20^{\circ}\text{C}$  (most details with extended temperature range has guaranteed parameters from  $-20^{\circ}\text{C}$ ) and partly with external installation at swift temperature changes and higher air humidity by switched heating no water condensation occurs on basic guard board, which assures its reliable function.

### 1.5 Change of nameplates

The first step is **dismantling of a fixing frame** from module, where we want to change a nameplate. It can be executed by unscrewing of two screws under plastic covers on fixing frame. When removing the fixing frame we can see two independent modules. The **front part**

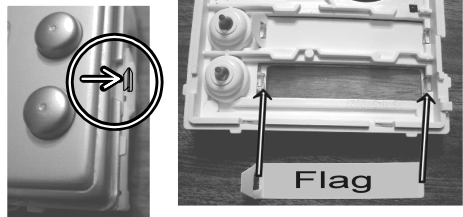

(metallic) of the button module has to be first separated from plastic part in this way that we will put off the **plastic lug**, ensuring the front part on the right side. Each button has its separate nameplate hold by means of plastic flag (see figure). The paper nameplates can be printed from Excel form (to be downloaded on [www.alphatech.cz](http://www.alphatech.cz)) or from Nset setting program.

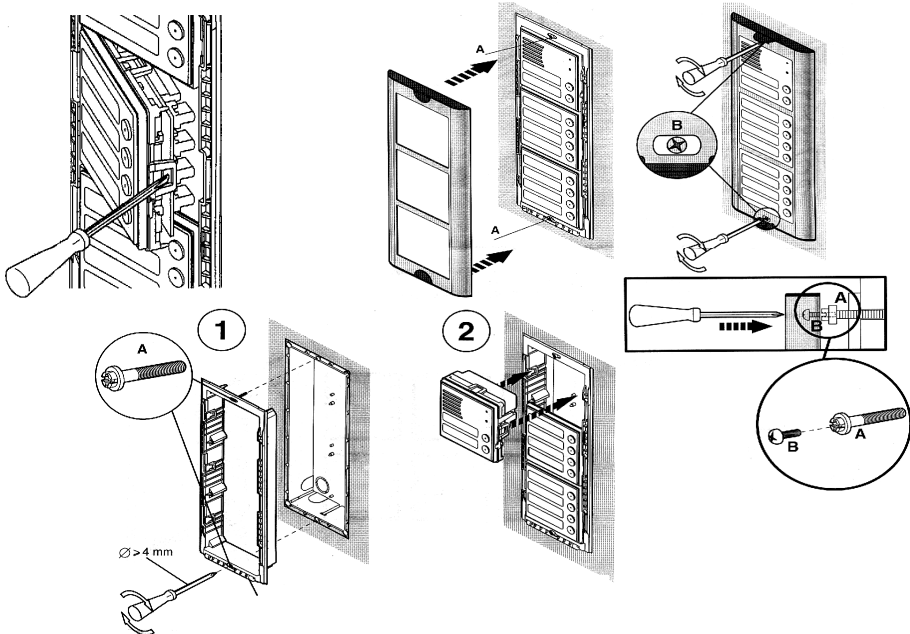

## 2 All-Purpose Guard Operation

### 2.1 Signaling Overview

The all-purpose guard signals an acoustic conditions they may occur during operation. Another signaling can be done by means of red LED (placed under microphone hole). You can listen the signaling samples in Nset setting program.

Condition	Tones	Tone frequency	LED
Line lifting up		425-850-1275	glows
Line hanging up		1275-850-425	goes out
Report after calling		425-850-1275	glows
Command confirmation from phone		425	
Dialing	DTMF/Pulse		goes out
Call			glows
Notice about call end		1275	glows
Entry to programming from phone		850	glows
Programming from phone		mod. 850	glows
Parameter confirmation			glows
Entry to programming from PC		850	glows
Programming from PC			blinks
Connection to line (Reset)		1275-850-1275	blinks
Error (anything, if unsuitable)		425....	
Empty memory (no progr. numb.)		850-1275-1700...	

### 2.2 Visitor at Door

The all-purpose guard function is influenced partly by used guard assembly (with keyboard or without it) and partly by setting of guard parameters (see chapter “Parameter Overview”).

#### 2.2.1 Guard without Keyboard

The guard **buttons** are provided by nameplates or positions of persons inside the object. The incoming person will press the corresponding button, the

guard will lift up the line neither immediately (the button is not the first number from code lock), or with delay (*parameter 53*) and after period given by *parameter 55* will dial the programmed phone number. The dialing number differs by choice mode, which is set in the guard (*parameter 47*):

- **Day/night mode** = being the guard in Day mode, so it is always dialing a number set in *parameter 1*, in Night mode, it is always dialing a number set in *parameter 2*. The mode switchover is set in *parameters 45,46*.
- mode of second number group = first press – it always dials a number set in *parameter 1*. By repeated press of the same button or detection of busy tone after dialing the guard will select the number from the second group (*parameter 2*). The next press of the same button again selects a number of the first group, etc.....

If a visitor presses the button after guard lifting up, so the guard will hang up for a period given by *parameter 54*, lift up the line and dial a new number. The number choice is carried out both tone (DTMF), and pulse dialing according to *parameter 41* setting.

The switch (**code lock**) can be controlled by first 10 buttons of guard. If the visitor at door presses buttons in such combination that meet the preprogrammed code (*parameters 32-34*) and the time among presses is not bigger than the set point (*parameter 53*), then the guard will lift up and close the corresponding switch (if set in m=1 or m=5 modes) to the period given by *parameter 36 event. 38*. Then it will hang up.

### 2.2.2 Guard with Keyboard

The guard with keyboard can also include besides the keyboard up to 18 buttons of direct dialing always behaving as to be mentioned in Chapter 2.2.1 except the code lock. This one is always situated on keyboard. After keyboard is connected, the position, where the keyboard is connected to, should be set (*parameter 48*).

The keyboard has two functional buttons – **key symbol** = once pressing the numerical combination is considered as the combination for control of the switches. The second button – **X symbol** = when pressing the guard immediately will hang up.

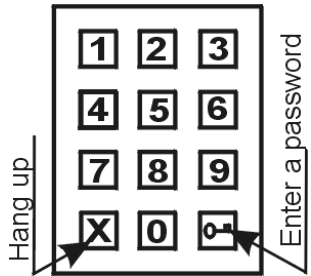

The number selection on keyboard can be executed in two ways (*parameter 49*):

- The incoming person is dialing number as to be done on phone – the period among button presses should be lower than the value given by *parameter 53*. After this period the guard will lift up and dial the given number.
- On buttons the incoming person is dialing a two-digit number (from 01 to 64), which represents the memory number, where the 16-digit number is stored (same as for buttons). The number dialing is

managed by Day/Night setting or mode for two groups of numbers (as described in Chapter 2.2.1).

## **2.3 Person Inside Object**

The person inside object is considered a person that is in phone contact with all-purpose guard.

### **2.3.1 Outgoing Call**

The outgoing call is the call from guard (caused by visitor). After guard choice the telephone is ringing inside object and the lifting up will allow speaking to the visitor at door. The code choice can close the switch (*parameter 35*), if set to m=1 or m=5 modes, change over the Day/Night modes (*parameters 45,46*) and hang up (*parameter 43*). The guard in 10 seconds before call end (*parameter 52*) will send a notice about call end and the call may be extended by sign selection (*parameter 42*). The telephone hanging up will end the call (the exchange is sending a busy tone on guard's line and the guard also will hang up).

### **2.3.2 Incoming Call**

The incoming call is the call from guard (caused by person inside object). After exchange number selection, where the guard is connected, the guard's line is ringing and when set number of rings is over (*parameter 51*), the guard will lift up and it is possible to speak. The possibilities are the same as with outgoing call (Chapter 2.3.1).

- Except the first 10 seconds, where extra "# and service password" (*parameter 44*) can be entered, the guard then will proceed with programming mode.
- The other exception of incoming call is by connected "SERVICE" jumper. The guard after line lifting up proceeds then with programming mode (without service password).

## 3 Programming of Parameters

---

### 3.1 Programming through Phone

#### 3.1.1 Entry to Programming

The all-purpose door guard will be set to programming mode in two ways:

1. **by password** – only incoming call! – answer the telephone and dial a number, where the guard is lined (*either branch number, if connected to branch exchange or number of state line to object, where the guard is placed and let you put through to branch directly connected with guard*). The guard will answer (you hear tone for answering – see Chapter 2.1 page 13) up to 10 sec dial **#xxxx**, where xxxx is the service number for entry to programming and if O.K., the registration tone to programming will sound and afterwards the programming tone is heard (see Chapter 13 page 13).
2. **by "SERVICE" jumper** – only incoming call! – you will realize the connection with guard in the same way as in art. 1, but when the SERVICE jumper is connected, then the guard after answering directly comes to programming mode – you hear tone for answering, registration tone to programming and afterwards the programming tone is heard. (see Chapter 2.1 page 13).

#### 3.1.2 Programming of parameters

The initial state for programming is signaled by programming tone and the guard will come back to this state always after time expiration (5 seconds) even you started to program anything.

When programming two types of parameters will occur. Partly they are parameters with **fixed length** – the majority of them they are, then the programming is affirmed and the parameter is always recorded immediately after mandatory length fulfillment by acknowledge tone and partly the parameters **with variable length** (*parameter 1,2,32,33,34*), followed with **confirmation** and the recording of the parameter after inactivity period expires (5 sec). The only case with immediate recording of parameters is the fulfillment of max. number of recorded signs (numbers) – by parameters 1 and 2 it is 16, by parameters 32,33,34 it is 6.

If during programming you enter number (sign) not allowable by its extent then the guard immediately emits an **error tone**, the parameter will not be recorded nor changed, the guard will come to initial state and it is possible to repeat the parameter setting or program another parameter.

The guard stays inactive in programming mode for 34 seconds, then he will automatically hang up. By every dialing of DTMF tone this period is set up repeatedly. The selection of parameter 9 can also end the programming mode.

**Note 1.** *if you wish to keep the connection (extend the 34 seconds period) than the customer will think over the other setting, so pressing e.g.. 6, 7, 0, p or # form time to*

*time will be sufficient and the guard immediately responds by error tone, but he will extend the period to hanging up..*

**Note 2.** *The # sign is not used by entering of 32,33,34 parameters can be used for immediate parameter entering.*

### **3.2 Programming from PC – Program Nset**

To guard's setup by means of personal computer (PC) the special KAB cable to serial port and Nset program should be available and the guard has to be connected to telephone line.

Procedure:

- Connect the NUDV to the line
- Line the guard with PC by KAB cable (if PC serial port absent, the USB-COM reduction is to be used). The guard will answer and LED light on the front panel will light.
- Run the Nset program – the guard will report the his conversion to PC programming mode (viz. chapter 2.1 page 13). After Nset program being run the guard is in this mode – this status is indicated by LED light on front panel by 1 second flashing. By loss of connection it is necessary to disconnect the cable from guard and connect it again – the guar will answer and if Nset program runs he will report his conversion to programming mode.

For details of setup refer to program help and on producer's pages [www.alphatech.cz](http://www.alphatech.cz).

## 4 Description of Parameters

### 4.1 Direct Dialing – Memories

Parameter	Value	Meaning	Basic	Exam.1	Exam.2
1	tt nn...	No. nn under button tt	-	-	-

**tt** – Button number (memory), always set in two-digit manner [01-64]

**nn** – telephone number up to 16 digits, we want to store. To store other choice flags the assignment given in table is used.

The numbers stored in parameter 1 are the number of the **first group** or numbers of **Day** mode.

Neither basic setting nor settings per examples do not change or delete the stored numbers.

mean.	choice
0 - 9	0 - 9
#	#
*	**
Flash	* #
Pause	*0

Parameter	Value	Meaning	Basic	Exam.1	Exam.2
2	tt nn...	No. nn under button tt	-	-	-

**tt** – Button number (memory), always set in two-digit manner [01-64]

**nn** – telephone number up to 16 digits, we want to store. To store other choice flags the assignment given in table is used..

The numbers stored in parameter 2 are the number of the **second group** or numbers of **Night** mode.

Neither basic setting nor settings per examples do not change or delete the stored numbers.

**Note:** The switchover to Day/Night mode remains set in guard even after line disconnection.

List of related parameters: **41 45 46 47 48 49 57 58 59 50 81 82**

mean.	choice
0 - 9	0 - 9
#	#
*	**
Flash	* #
Pause	* 0

### 4.2 Switches

Parameter	Value	Meaning	Basic	Exam.1	Exam.2
31	r m	switch r works in m mode	11 21	11 22	11 25

**r** – switch number [1-2]

**m** – switch mode [for r=1 1-4 , for r=2 1-5]

**m=1 switch** mode – it will close on command or password for **ss** period (used for electrical locks, gate opening etc.)

**m=2 camera** mode – it will close by guard lifting up and open by hanging up.

**m=3 lighting** mode – it will close by guard lifting up and stay closed even for **ss** period after guard hanging up (the line is engaged for this period).

**m=4 switch** mode – it will close after button pressing and open after **ss** period (used for e.g. external bell or horn connections).

**m=5 gradual opening** mode – in this mode the only switch 2 will be set together with switch 1 set to mode 1. The switch 1 is activated for **ss** period, then the time **xx** is proceeding before switch 2 closing. Then the switch 2 is activated for **ss** period and afterwards the guard hangs up.

**Note:** The only switch 1 can be activated from phone and all sequence started. Besides that the switch 2 can be separately activated from buttons by password.

List of related parameters: **32 33 34 35 36 37 38 8# 83**

Parameter	Value	Meaning	Basic	Exam.1	Exam.2
32	r hhhhhh	passw. hhhhhh for switch r in <b>DAY + NIGHT</b> mode	-	1 121 2 122	1 4561 2 4562
33	r hhhhhh	passw. hhhhhh for switch r in <b>DAY</b> mode	-	-	-
34	r hhhhhh	passw. hhhhhh for switch r in <b>NIGHT</b> mode	-	-	-

r – switch number [1-2]

hhhhhh – password for switch closing from buttons or keyboard [2 to 6 digits]

Total 6 passwords, they are controlled by Day/Night; the combination is entered either by guard buttons (first 10 buttons) or from attached keyboard (after pressing of key symbol). The switch closing influences the set switch mode and **Day/Night** switchover. By setting of choice mode of **2 number groups** the guard is permanently in **DAY** mode.

By password choice some rules have to be observed:

- Select passwords in way not to find its combination out from wear of certain buttons by frequent use.
- Select the first password button from frequentless button for direct dialing (-extends choice time)(-not valid for keyboard).
- Pay attention to congruity of password numbers when one password includes other one, e.g. switch 1 has 1234 and switch 2 has 12345. Then after pressing button 4 the only switch 1 is called, but password choice 234 for switch 2 can call both switches after pressing switch 4.

**Note:** The switchover to Day/Night mode remains set in guard even after line disconnection.

List of related parameters: **31 35 36 37 38 45 46 47 48 49 53 8# 83**

Parameter	Value	Meaning	Basic	Exam.1	Exam.2
35	r aa	command aa from phone after r switch closing	155 266	155 266	155 266

r – switch number [1-2]

aa – command from phone after switch closing [2 digits]

The same command can be set for both switches, then they are activated at the same time. The advantage is to set the same command both for switch closing and command to guard hanging up (*parameter 43*) **aa=bb**.

List of related parameters: **31 36 37 38 43 8# 83**

Parameter	Value	Meaning	Basic	Exam.1	Exam.2
<b>36</b>	<b>r ss</b>	<b>ss</b> period [sec] of <b>r</b> switch closing	105 205	102 202	105 205

**r** – switch number [1-2]

**ss** – duration of switch closing [2 digits 01-99]

List of related parameters: **31 32 33 34 35 37 38 8# 83**

Parameter	Value	Meaning	Basic	Exam.1	Exam.2
<b>37</b>	<b>r p</b>	<b>r</b> switch control by incoming call	11 21	11 21	11 21

**r** – switch number [1-2]

**p** – parameter, if **p=1** allowed or **p=0** prohibited to control the switch during incoming call.

To prohibit the control during incoming call is important e.g. when using switch 2 in mode 1 for control of garage gate opening, when the electronics opens the gate and the gate is closed by car passage. Then the control from phone could undesirably cause the permanent gate opening (not closed – no car passage).

List of related parameters: **31 35 8# 83**

Parameter	Value	Meaning	Basic	Exam.1	Exam.2
<b>38</b>	<b>xx</b>	<b>xx</b> period [sec] between switches 1 and 2 closing	10	10	15

**xx** – time between close switches 1 and 2 by **m=5** mode setting (gradual opening) [2 digits 01-99]

List of related parameters: **31 32 33 34 35 36 37 8# 83**

### 4.3 Basic Parameters

Parameter	Value	Meaning	Basic	Exam.1	Exam.2
<b>41</b>	<b>v</b>	choice type <b>v</b> – tone / pulse	0	0	0

**v** – choice type **v=0** is DTMF tone choice, **v=1** is pulse choice

List of related parameters: **1 2 8# 84**

Parameter	Value	Meaning	Basic	Exam.1	Exam.2
42	z	sign for call extension	ρ	ρ	ρ

**z** – sign for call extension ρ or # (10sec before call end the guard will send a notice, then the call may be extended)

List of related parameters: **52 8# 84**

Parameter	Value	Meaning	Basic	Exam.1	Exam.2
43	g bb	command for guard hanging up from phone	155 266	155 244	155 244

**g** – command order [1-2] (two commands in order to hang up the guard using both switches)

**bb** – command for guard hanging up from phone [2 digits]

The advantage is to set the same command both for switch closing (*parameter 35*) and command to guard hanging up **aa=bb**.

List of related parameters: **35 8# 84**

Parameter	Value	Meaning	Basic	Exam.1	Exam.2
44	xxxx	service password	0000	0000	0000

**xxxx** – service password for entry to programming

List of related parameters: **8# 84**

Parameter	Value	Meaning	Basic	Exam.1	Exam.2
45	dd	command for <b>DAY</b> switching	11	11	11
46	nn	command for <b>NIGHT</b> switching	10	10	10

**dd** – command for **DAY** mode switching [2 digits]

**nn** – command for **NIGHT** mode switching [2 digits]

**Note:** The switchover to Day/Night mode remains set in guard even after line disconnection.

List of related parameters: **1 2 33 34 47 8# 84**

Parameter	Value	Meaning	Basic	Exam.1	Exam.2
47	e	mode of guard choice	1	1	0

**e** – mode of guard choice **e=0** selects numbers of the first and second groups, **e=1** selects number per **Day/Night** guard mode.

List of related parameters: **1 2 8# 84**

**ATTENTION !!** This parameter setting will sharply influence the dialing.

Parameter	Value	Meaning	Basic	Exam.1	Exam.2
48	c	keyboard connection	0	0	1

- c – c=0 only NC-mode connected to the basic module  
c=1 the keyboard connected on the first position  
c=2 the keyboard connected on the second position  
c=3 the keyboard connected on the third position

**ATTENTION !!** This parameter setting will sharply influence whole guard function.

List of related parameters: **1 2 32 33 34 47 49 53 8# 84**

Parameter	Value	Meaning	Basic	Exam.1	Exam.2
49	o	keyboard mode	0	1	0

- o – o=0 dialing as on normal telephone (all number of called person should be pressed on keyboard).  
o=1 Only 2-digit memory number is entered on keyboard by which the number of called person is stored (memory number corresponds to button number with respect to Day/Night switchover).

**ATTENTION !!** This parameter setting will sharply influence keyboard function.

List of related parameters: **1 2 47 48 53 8# 84**

#### 4.4 Time Parameters

Parameter	Value	Meaning	Basic	Exam.1	Exam.2
51	q	number of rings before guard call lifting up	2	1	2

- q – Number of incoming call rings, the guard lifts up among rings namely 2 sec. after detection q – times rings. The number can be set from 1 to 9.

List of related parameters: **44 8# 85**

Parameter	Value	Meaning	Basic	Exam.1	Exam.2
52	d	max. call time	2	2	1

- d – max. time, for which the guard is hanging up, this time can be extended during call by sign choice from telephone (\* or #). Time setting is per table.

List of related parameters: **42 8# 85**

time [min]	choice
0,5	0
1 - 9	1 - 9
15	*
30	#

Parameter	Value	Meaning	Basic	Exam.1	Exam.2
53	w	time among button presses	2	2	2

**w** – max. time [sec] among button presses [range 1-9]

- **normal buttons**

- **switch closing** – if time between two next presses is bigger than **w** time, the code is not evaluated correctly.
- **dialing** – if the button, we are pressing, is the first password number for switch closing, so the choice is delayed by this **w** time.

- **keyboard**

- **switch closing** – if time between two next presses is bigger than **w** time, the code is not evaluated correctly.
- **dialing**
  - dialing the same as of phone, if time after the last pressed button is bigger than **w** time, then the dialing starts. If the number is incomplete, it is necessary to hang up (**X** button) and the dialing will be repeated.
  - dialing from memory, if time following the first pressed button is longer than **w** time, then the entry of memory number has to be repeated.

List of related parameters: **1 2 32 33 34 47 48 49 8# 85**

Parameter	Value	Meaning	Basic	Exam.1	Exam.2
54	z	time of hanging up when dialing repeated	2	2	2

**z** – time [sec] for which the guard will hang up, before repeated dialing (button pressing during call or dialing, busy tone detection) [range 1-5]

List of related parameters: **8# 85**

Parameter	Value	Meaning	Basic	Exam.1	Exam.2
55	z	time before dialing	1	1	1

**z** – time [sec] after guard lifting up before dialing [range 1-5]. This time is different for each exchange, but most central exchanges usually manage to process dialing up to 2 seconds after line lifting up.

List of related parameters: **8# 85**

Parameter	Value	Meaning	Basic	Exam.1	Exam.2
56	h	number of rings before hanging up	12	12	12

**h** – after finishing the dialing it calculates number of KVT (ringing tones). If the number exceeds **h** value, it will hang up [range 04-99]. The dialing is repeated in case, when the dialing mode of 2 groups is set.

List of related parameters: **47 8# 85**

Parameter	Value	Meaning	Basic	Exam.1	Exam.2
57	t	DTMF tone duration (tone choice)	5 (100ms)	5 (100ms)	5 (100ms)
58	m	gap duration among DTMF tones	5 (100ms)	5 (100ms)	5 (100ms)
59	f	Flash duration	1 (100ms)	1 (100ms)	1 (100ms)
50	p	pause duration / interdigit gap	8 (800ms)	8 (800ms)	8 (800ms)

**t** – DTMF tone duration is determined per formula:

$$(\text{entered number} + 5) \times 10 = \text{tone duration} \text{ [ms]}$$

[range 1-0 i.e. 60-150ms]

**m** – gap duration among DTMF tones is determined per formula:

$$(\text{entered number} + 5) \times 10 = \text{gap duration} \text{ [ms]}$$

[range 1-0 i.e. 60-150ms]

**f** – Flash duration is determined per formula:

$$\text{entered number} \times 100 = \text{Flash duration} \text{ [ms]}$$

[range 1-6 i.e. 100-600ms]

**p** – pause duration is determined per formula:

$$\text{entered number} \times 100 = \text{pause duration} \text{ [ms]}$$

[range 5-0 i.e. 500-1000ms]

– **p** time is simultaneously the duration of interdigit gap at pulse dialing.

List of related parameters: **1 2 41 8# 85**

## 4.5 Presetting and Deleting

Parameter	Value	Meaning	Basic	Exam.1	Exam.2
8#	#	basic setting	executes		
8#	1	setting per exam. 1		executes	
8#	2	setting per exam. 2			executes

This setting does not influence 1 and 2 (numbers stored in memory)

Parameter	Value	Meaning	Basic	Exam.1	Exam.2
81		deletes all numbers in group 1 (Day mode)			
82		deletes all numbers in group 2 (Night mode)			
83		basic setting only for parameters 3x	only 3..		
84		basic setting only for parameters 4x	only 4..		
85		basic setting only for parameters 5x	only 5..		

The parameters 81 and 82 will execute deleting of all numbers stored in memories for buttons.

The parameters 83 – 85 will execute a selective basic setting only for parameters starting with 3.. – 5..

**ATTENTION !!!** the deleting is non-reversible !!!, It is then necessary to program it again.

## 4.6 Programming Termination

Parameter	Value	Meaning	Basic	Exam.1	Exam.2
9		E N D			

After dialing 9 to programming tone the guard will hang up.

## 4.7 System Setting

Parameter	Value	Meaning	Basic	Exam.1	Exam.2
6#	s	number of non-fitted buttons of basic module			

The basic module is fitted with 2 buttons as standard, i.e.  $s = 0$ ,  $s = 1$  is set up for basic module with one button and  $s = 2$  for module without buttons. This setting is a factory one, no service can change it and so it is recommended not to change this parameter.

*Note: Connecting to the line the value of this parameter is checked and if not satisfactory form unknown reasons, so it is set up to  $s = 0$  (fitted with 2 buttons).*

**Attention !!! This parameter does not basically affect the correct function of guard.**

Parametr	Value	Description	Basic	Exam.1	Exam.2
6	z	Switching off acoustic signalization	3	3	3

In default is status of Door phone signalling acoustically. It can cause a problem of incorrect detection of tones by PBX. By parametr „z“ you can switch off this acoustic signalization. The values are

$z=0$  – all signalling is switched off

$z=1$  – pick up and hang up tones are active only

$z=2$  – other tones active only (except pick up and hang up)

$z=3$  – all tones are active – default

Parametr	Value	Description	Basic	Exam.1	Exam.2
6*	t	Delay of line connection ( Siemens PBX)	1	1	1

The delay of line picks up ( OFF HOOK) for new PBX types (particularly Siemens) is:

$t=1$  – standard operation

$t=0$  – delayed start

## 4.8 Overview of Parameters

Parameter	Value	Meaning	Basic	Exam.1	Exam.2
1	tt nn...	No. nn under button tt	-	-	-
2	tt nn...	No. nn under button tt	-	-	-
31	r m	switch r works in m mode	11 21	11 22	11 25
32	r hhhhhh	pasw. hhhhhh for r switch	-	1 121	1 4561

		in <b>DAY + NIGHT</b> mode		2 122	2 4562
<b>33</b>	<b>r hhhhhh</b>	pasw. <b>hhhhhh</b> for <b>r</b> in <b>DAY</b> mode	-	-	-
<b>34</b>	<b>r hhhhhh</b>	pasw. <b>hhhhhh</b> for <b>r</b> in <b>NIGHT</b> mode	-	-	-
<b>35</b>	<b>r aa</b>	command <b>aa</b> from phone after <b>r</b> switch closing	155 266	155 266	155 266
<b>36</b>	<b>r ss</b>	<b>ss</b> period [sec] of <b>r</b> switch closing	105 205	102 202	105 205
<b>37</b>	<b>r p</b>	<b>r</b> switch control by incoming call	11 21	11 21	11 21
<b>38</b>	<b>xx</b>	<b>xx</b> period [sec] between switches 1 and 2 closing	10	10	15
<b>41</b>	<b>v</b>	choice type <b>v</b> – tone / pulse	0	0	0
<b>42</b>	<b>z</b>	sign for call extension	ρ	ρ	ρ
<b>43</b>	<b>g bb</b>	command for guard hanging up from phone	155 266	155 244	155 244
<b>44</b>	<b>xxxx</b>	service password	0000	0000	0000
<b>45</b>	<b>dd</b>	command for <b>DAY</b> switching	11	11	11
<b>46</b>	<b>nn</b>	command for <b>NIGHT</b> switching	10	10	10
<b>47</b>	<b>e</b>	mode of guard choice	1	1	0
<b>48</b>	<b>c</b>	keyboard connection	0	0	1
<b>49</b>	<b>o</b>	keyboard mode	0	1	0
<b>51</b>	<b>q</b>	number of rings before guard call lifting up	2	1	2
<b>52</b>	<b>d</b>	maximum call time	2	2	1
<b>53</b>	<b>w</b>	time among button presses	2	2	2
<b>54</b>	<b>z</b>	time of hanging up when dialing repeated	2	2	2
<b>55</b>	<b>z</b>	time before dialing	1	1	1
<b>56</b>	<b>h</b>	number of rings before hanging up	12	12	12
<b>57</b>	<b>t</b>	DTMF tone duration (tone) choice	5 (100ms)	5 (100ms)	5 (100ms)
<b>58</b>	<b>m</b>	gap duration among DTMF tones	5 (100ms)	5 (100ms)	5 (100ms)
<b>59</b>	<b>f</b>	Flash duration	1 (100ms)	1 (100ms)	1 (100ms)

<b>50</b>	<b>p</b>	pause duration / interdigit gap	8 (800ms)	8 (800ms)	8 (800ms)
<b>8#</b>	<b>#</b>	basic setting	executes		
<b>8#</b>	<b>1</b>	setting per exam. 1		executes	
<b>8#</b>	<b>2</b>	setting per exam. 2			executes
<b>81</b>		deletes all numbers in group 1 (Day mode)			
<b>82</b>		deletes all numbers in group 2 (Night mode)			
<b>83</b>		basic setting only for parameters 3x	only 3..		
<b>84</b>		basic setting only for parameters 4x	only 4..		
<b>85</b>		basic setting only for parameters 5x	only 5..		
<b>9</b>		E N D			

## 4.9 List of Presetting Parameters

parameter	bas. cast.	example 1	example 2
switch 1 mode	lock m=1	lock m=1	lock m=1
switch 2 mode	lock m=1	camera m=2	prog. m=5
passw.Day+Night switch 1	not	121	4561
passw. Day+Night switch 2	not	122	4562
passw.Day switch 1	not	not	not
passw.Day switch 2	not	not	not
passw. Night switch 1	not	not	not
passw. Night switch 2	not	not	not
switch 1 activ. from phone	55	55	55
switch 2 activ. from phone	66	66	66
closing time of switch 1 and 2	5 sec	2 sec	5 sec
con. by incoming call	allowed	allowed	allowed
delay among ap. during oper.	10 sec	10 sec	15 sec
choice	DTMF	DTMF	DTMF
sign of call extension	ρ	ρ	ρ
hanging up from phone 1 / 2	55 / 66	55 / 44	55 / 44
service password	0000	0000	0000
switching to day mode	11	11	11
switching to night mode	10	10	10
guard choice mode	Day/Night	Day/Night	2 groups
keyboard connection	no	no	on 1 <sup>st</sup> place
keyboard mode	dialing	memory numbers	dialing
number of rings of incoming call	2	1	2
max. call time	2 min	2 min	1 min
time among button presses	2 sec	2 sec	2 sec
time of hanging up when dialing repeated	2 sec	2 sec	2 sec
time before dialing	1 sec	1 sec	1 sec
number of rings before hanging up	12	12	12
DTMF tone duration (tone) choice	100ms	100ms	100ms
gap duration among DTMF tones	100ms	100ms	100ms
Flash duration	100ms	100ms	100ms
pause duration / interdigit gap	800ms	800ms	800ms

**Note:** The minimum setting and both examples can be customized by expected purchase of min. 10pcs of NUDV.

## 5 Technical Parameters

### 5.1 Electrical Parameters

Parameter	Value	Conditions
Minimum line current	18mA	line answered
Minimum line voltage	18V	line hang up
Voltage on line while guard answers (VA characteristics)	< 8V < 12V	I = 20mA I = 60 mA
Leakage in hang up status	< 50uA	U = 60V
Impedance of line termination	130R + 820R paral. 220n	line answered
Band width	300Hz – 3400 Hz	20 - 60mA
Impedance of ringing	> 2Kohm	25 – 60 Hz
Sensitivity of ringing detector	min. 10 – 25 V	
Pulse choice	40 / 60 ms	
Tone choice level	4 a 6 dB	20 – 60 mA
Tone choice sensitivity	40 dB	20 – 60 mA
Sensitivity of tone detector	30 dB	20 – 60 mA
Power supply of lighting through, switches and heating	12Vss ± 2V , 10-12Vst ± 2V	
Max. consumption of lighting through and heating	300mA	12Vss
Max. voltage of switch contact	48V	at I < 1A
Max. current of switch contact	2A	at U < 30 V
Operational temperature	- 20 to + 50°C	

### 5.2 Mechanical dimensions

Type of item	dimensions HxWxD [mm]			
	1 module	2 modules	3 modules	4 modules
MKxx mount. box	114x118x45	204x118x45	294x118x45	384x118x45
KPDxx (on plast.)1col.	151x157x79	241x157x79	331x157x79	421x157x79
KPDxx (on plast.)2col.	-	241x286x79	-	421x286x79
Canopy xx	149x151x49	241x151x49	331x151x49	421x151x49
Fixing frame	147x151x3	239x151x3	299x151x3	399x151x3

## 6 Table for Easy Programming

Complete the values in empty part of table you want to program. In double-frame part there are whole programming commands, so the programming is very simple and without errors. Furthermore such programmed values will be available for next changes in manual.

Meaning		Programming sequence		num. of point
Description	Spec.	par.	Complete your values	
Number under button 1	Day/1gr.	101		16
Number under button 2	Day/1gr.	102		16
Number under button 3	Day/1gr.	103		16
Number under button 4	Day/1gr.	104		16
Number under button 5	Day/1gr.	105		16
Number under button 6	Day/1gr.	106		16
Number under button 7	Day/1gr.	107		16
Number under button 8	Day/1gr.	108		16
Number under button 9	Day/1gr.	109		16
Number under button 10	Day/1gr.	110		16
Number under button 11	Day/1gr.	111		16
Number under button 12	Day/1gr.	112		16
Number under button 1	Night/2gr.	201		16
Number under button 2	Night/2gr.	202		16
Number under button 3	Night/2gr.	203		16
Number under button 4	Night/2gr.	204		16
Number under button 5	Night/2gr.	205		16
Number under button 6	Night/2gr.	206		16
Number under button 7	Night/2gr.	207		16
Number under button 8	Night/2gr.	208		16
Number under button 9	Night/2gr.	209		16
Number under button 10	Night/2gr.	210		16
Number under button 11	Night/2gr.	211		16
Number under button 12	Night/2gr.	212		16
Switch 1 works in mode	m=1 - 4	311		1
Switch 2 works in mode	m=1 - 5	312		1

Password for switch 1	Day+Night	<b>321</b>		6
Password for switch 2	Day+Night	<b>322</b>		6
Password for switch 1	Day	<b>331</b>		6
Password for switch 2	Day	<b>332</b>		6
Password for switch 1	Night	<b>341</b>		6
Password for switch 2	Night	<b>342</b>		6
Clos. of switch 1 fr. phone		<b>351</b>		2
Clos. of switch 2 fr. phone		<b>352</b>		2
Closing time of switch 1	[sec]	<b>361</b>		2
Closing time of switch 2	[sec]	<b>362</b>		2
Sw. cont.1 by incoming call	1 / 0	<b>371</b>		1
Sw. cont.2 by incoming call	1 / 0	<b>372</b>		1
Time between 1 and 2 switch closing	[sec]	<b>38</b>		2
Tone/pulse tone choice	1 / 0	<b>41</b>		1
Sign of call extension	* / #	<b>42</b>		1
Guard hang. up from phone	1.	<b>431</b>		2
Guard hang. up from phone	2.	<b>432</b>		2
Service password		<b>44</b>		4
Comm. to <b>DAY</b> switching		<b>45</b>		2
Comm. to <b>NIGHT</b> switching		<b>46</b>		2
Guard choice mode	1 / 0	<b>47</b>		1
Keyboard connection	0/1/2/3	<b>48</b>		1
Keyboard mode	1 / 0	<b>49</b>		1
Number of rings for ringing		<b>51</b>		1
Maximum call duration	[min]	<b>52</b>		1
Time among button press.	[sec]	<b>53</b>		1
Hang. up time when dialing repeated	[sec]	<b>54</b>		1
Time before dialing start	[sec]	<b>55</b>		1
Num. of rings bef. hang. up		<b>56</b>		2
Duration of dialing tone	(n+5)x10	<b>57</b>	ms	1
Gap among DTMF tones	(n+5)x10	<b>58</b>	ms	1
Flash duration	nx100	<b>59</b>	ms	1
Pause durat. / interdigit gap	nx100	<b>50</b>	ms	1

# 7 DECT – DistyBox

## 7.1 DistyBox Description

This module is a separate box allowing the connection of end analogue telecommunication device to wireless system DECT – GAP (e.g. Siemens line GigaSet, TopCom line Butler etc.). DistyBox is suitable for guard connection, because it is not necessary to place the conductors from house to the gate and to address to base station is enough sufficient. All guard features are reserved.

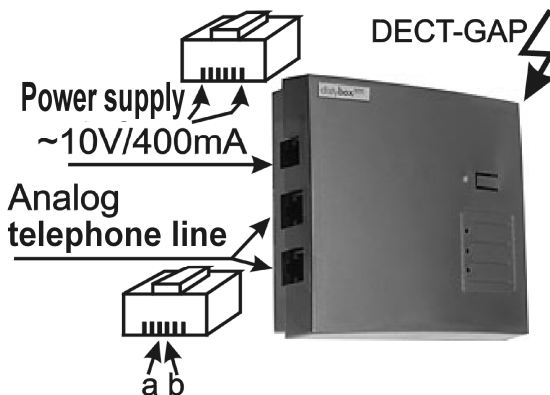

DistyBox must be energized to power supply and the guards to outputs of analogue line (indicated on figure) – both outputs of analogue line are parallel. The DistyBox300 contains an internal antenna allowing the connection of 300 m direct visibility and 50 m in building. The DistyBox5000 can be fitted with an external antenna increasing the range to 6 km.

## 7.2 DistyBox Signaling

### LED indication

| Time interval is 8sec |  
switched off



### Tones

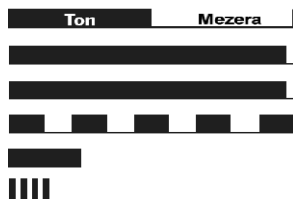

## 7.3 DistyBox Programming

You can enter the programming mode 20 sec – 10min after power supply ON by **pp9** choice (to dial/busy tones) namely after DistyBox power supply ON. If you had entered a new PIN in previous programming (par.2) so now you must enter a correct **PIN** for entry to programming (following main reset (par. 90) the PIN should not be entered). The special dialing tone is heard in programming mode. The entry and correct PIN are confirmed by confirmation tone, the false PIN by error tone.

Param.	Value	Meaning
pp9	[xxxx]	entry to programming, xxxx=PIN, if entered
0	#	log off – stored DECT parameters will be deleted
1	xxxxxxx #	entry code to base station (4-8 numbers)
2	xxxx yyyy #	PIN change - xxxx is old, yyyy is new, <b>0000</b> is firm one
3	0# - 79#	distance – number load is multiple of 130m (300m = 3)
40	0# / 1#	choice mode - <b>0</b> sends / 1 suppresses DTMF choice transmission from base station ( <b>0</b> is pract. doubled choice)
41	0# / 1#	operational setting - <b>0</b> is phone / 1 is FAX
70	0# / 1# / 2#	call limitation - <b>0</b> not limited, 1 incoming, 2 outgoing
71	0# / 1# / 2#	type of call - 0 both, 1 internal, 2 external call
72	xxx #	Flash length – xxx times 10ms (100ms = 010) firm.= <b>210ms</b>
90	#	reset and company setting (bold), presets all
91	#	reset and company setting (bold), log in parameters will be kept
92	0# / 1#	autoreset <b>0</b> -inactive / 1-active (every 24 hrs will end all transmissions and recall to base station)

Settings for use with guard: (90#), 401#, 410#, 700#, 710#

**Internal call** will be executed by pp $\underline{s}$ , where  $\underline{s}$  is 0-9 i.e. number of internal station, station 9 may be called 10min after power supply ON, up to this moment it is entry to programming.

**Note:** The switching of call/internal query can be made by “Flash” and pp $\underline{s}$  choices. The call will be switched over by hanging up. The “Flash” function will turn back to previous call.

## 7.4 Log on to Base Station

The log in might be done automatically in this way that we hold the button for searching on base station (min 3sec) and then we will connect the power supply to DistyBox. This will automatically log on to base station within 1 min and if not made it is recommended to make the company reset (90#) and repeat logging on. Setting of parameters 401#, 410#, 700#, 710# is required.

**Be sure** about parameter 40, which is being set after company reset thus that the choice is transmitted not only by guard, but also the base station so that the choice is executed twice!!

**Guarantee conditions:**

The product was shop-checked. The producer guarantees that this product will keep the features described in these operating instructions in the course of guarantee provided that the user will be handled with it as described in the operating manual. The guarantee will be extended by period of possible guarantee repair.

When claiming in guarantee period please contact your dealer. The producer only will make the guarantee repairs. Attach the description of claim reason, proof of purchase and your exact address to the product.

**The guarantee does not include:**

- mechanical, thermal, chemical and other damages caused by user's activities
- defects caused by natural disasters
- defects caused by repair or changes carried out by user or other unauthorized person
- willful damage of product
- incorrect use of product caused by other use than specified in operating manual (e.g. installation, programming)
- damages caused during product transport to customer and from supplier

Producer:
Dealer:
Date of sale:

Registered company address:

**TELSYCO, s.r.o.**  
Prostřední 627/14  
141 00 Praha 4  
Czech Republic  
**VAT: CZ28548302**

Company is registered in the Commercial Register  
administered by the Municipal Court in Prague, Section  
C, Record 149478

**TELSYCO s.r.o.**  
**Office:**  
Kyjovská 1983/1  
142 00 Praha 4  
Czech Republic  
E-mail: [info@telsyco.com](mailto:info@telsyco.com)  
Tel/Fax: +420 241 765 832